

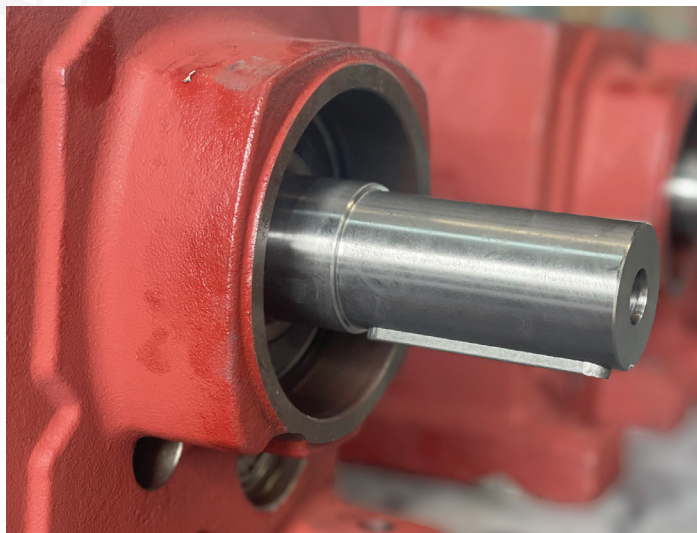

 **dinamik**  
m o t o r r e d ü k t ö r

*Forever in Motion*

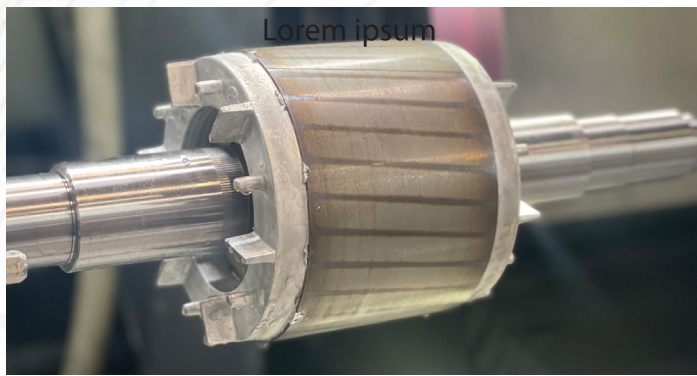

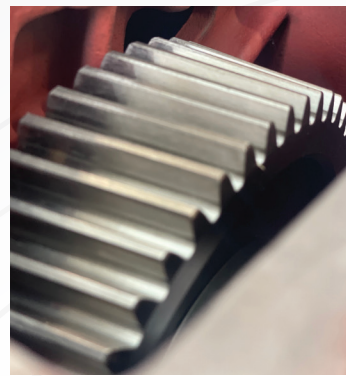

 **dinamik**  
motor redüktör



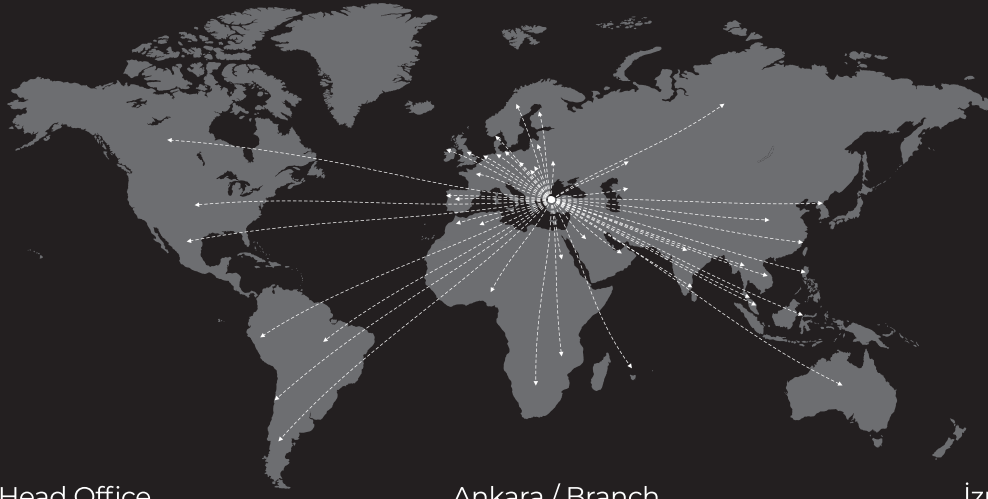

Istanbul / Head Office

Ankara / Branch

Izmir / Factory



## About Us

Dinamik has been in the industry for over 30 years, and this extensive experience has greatly contributed to its success. This has made “Dinamik” stand out in the market and make a significant impact in a short period of time.

In line with its commitment to excellence, Dinamik has made significant investments in advanced technology and equipment.

Dinamik carries out high-tech production with state-of-the-art machines in a total area of 25,000 m<sup>2</sup> in 2024.

As a Dinamik company, we are constantly striving for growth and improvement. This has been recognized by our inclusion in the top 100 fastest growing companies in Turkey in 2023. This achievement serves as a testament to our hard work and determination to make a difference in the sector.

# GEARBOX

## DAF Series

Type	Moment (Nm)
DAF00	82
DAF10	140
DAF17	200
DAF20	280
DAF27	450
DAF28	600
DAF37	820
DAF47	1550
DAF57	3000
DAF67	4300
DAF77	8000
DAF87	13000
DAF97	18000

13 size DAF 00 - 97  
Nominal Torque (M2) up to 18000 Nm  
Transmission ratio (i) 3,83 ... 12921

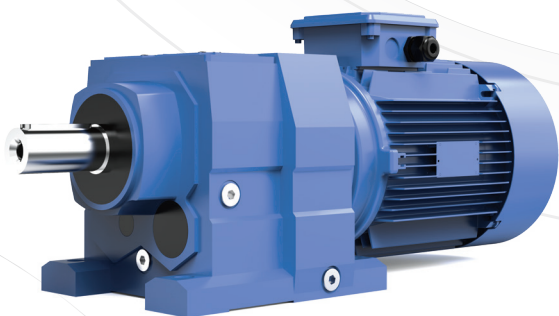
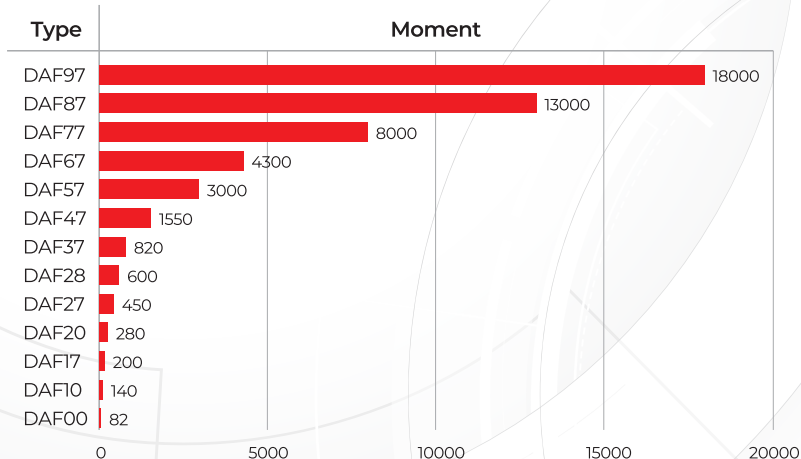

### Features

- Cast iron housing
- B14 / B5 input flange options on the housing
- Helical toothed gear pairs with ground profile
- Special output flange options

### Benefits

- Longer life
- High efficiency design
- Minimum maintenance requirements
- High performance and greater reliability
- Available modular assembly system

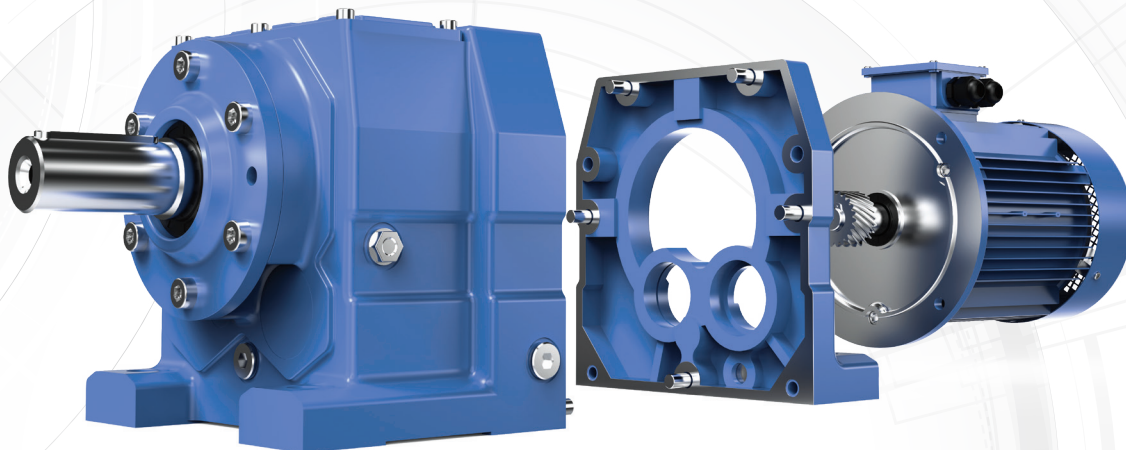
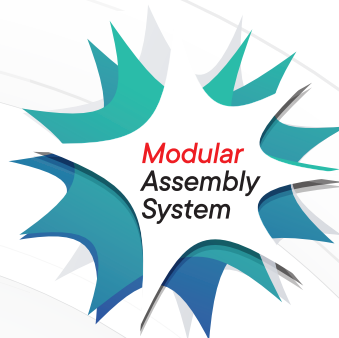

# GEARBOX

## DK Series

Type	Moment (Nm)
DK17	200
DK27	450
DK37	820
DK47	1550
DK57	2700
DK67	4300
DK77	8000

7 size DK17 - 77  
Nominal Torque (M2) up to 4870 Nm  
Transmission ratio (i) 5,36 ... 14311

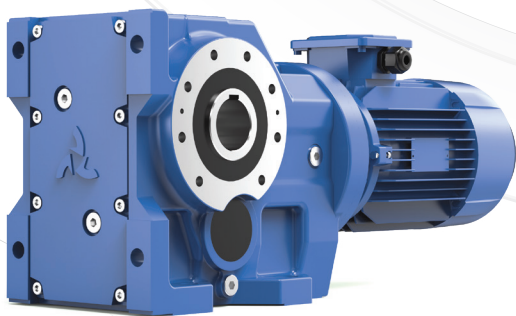
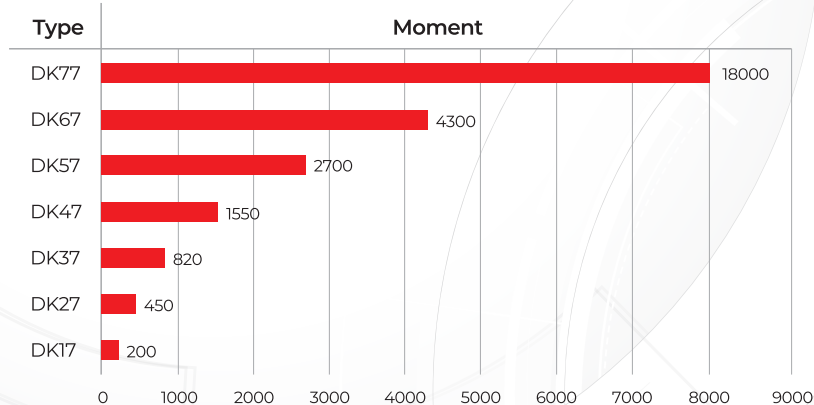

### Features

- Interchangeable standards
- Gear precision as per DIN/ISO 6 or better
- New IE3/IE4 normal and compact type electric motors
- High quality sealing solutions
- Smooth housing surface
- Higher torque

### Benefits

- Superior quality, minimum maintenance
- High performance
- Energy saving, low noise level
- Available modular assembly system

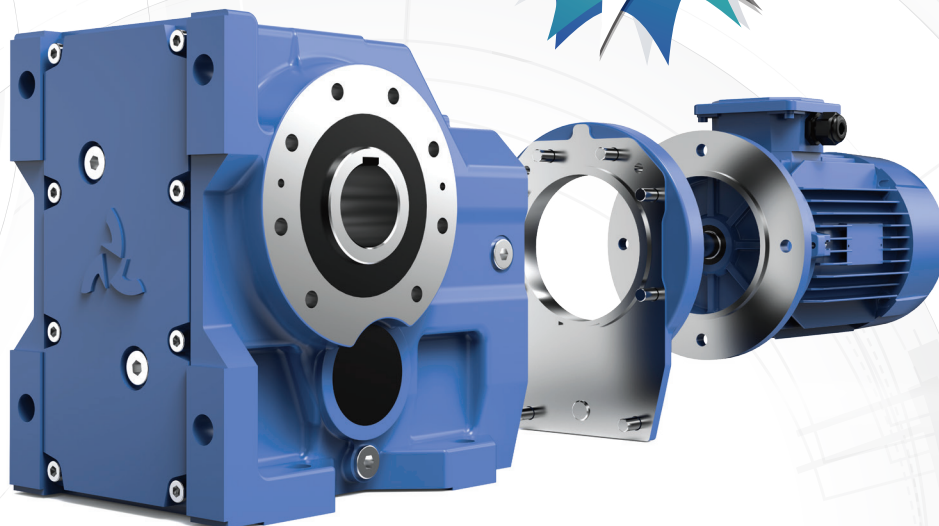
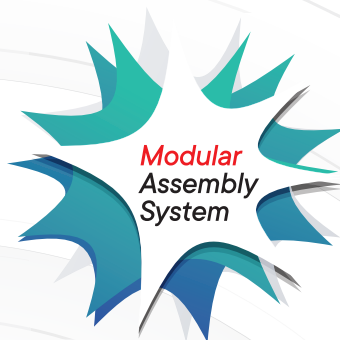

# GEARBOX

## DP Series

Type	Moment (Nm)
DP07	150
DP17	200
DP27	450
DP28	600
DP37	820
DP47	1550
DP57	3000
DP67	4300
DP77	8000
DP87	13000
DP97	18000

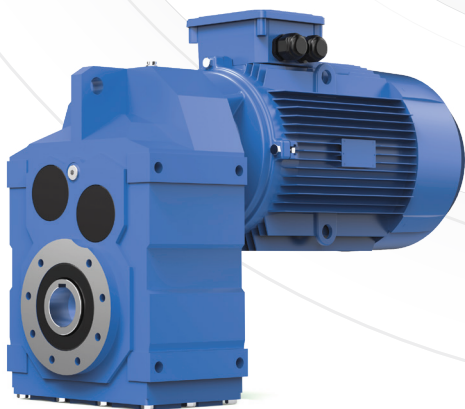

11 size DP 07 - 97  
Nominal Torque (M2) up to 18000 Nm  
Transmission ratio (i) 4,9 ... 19048

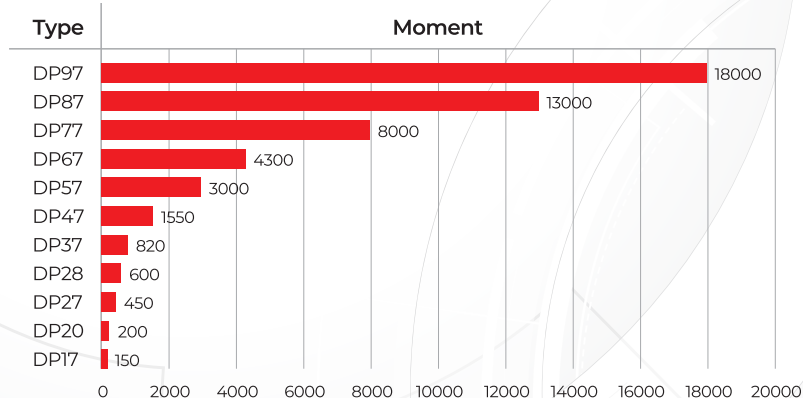

### Features

- Cast iron housing
- Universal mounting with lower/upper feet and B5-B14 flange integral to the housing
- Helical toothed gear pairs with ground profile
- Special output flange options
- Special long shaft options

### Benefits

- Longer life
- High efficiency design
- Minimum maintenance requirements
- High performance and greater reliability

## DS Series

Type	Moment (Nm)
DS030	24
DS040	54
DS050	86
DS063	164
DS075	252
DS090	335
DS110	593
DS130	1084
DS150	1351

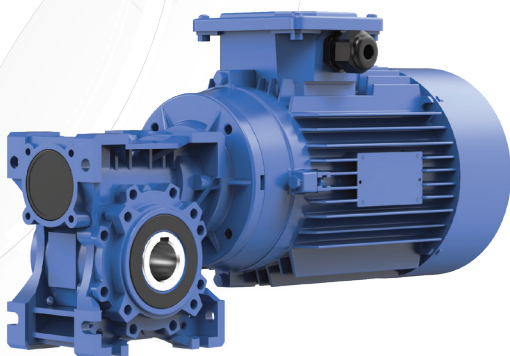

9 size DS 30 - 150  
Nominal Torque (M2) up to 1760 Nm  
Transmission ratio (i) 5 ... 2400

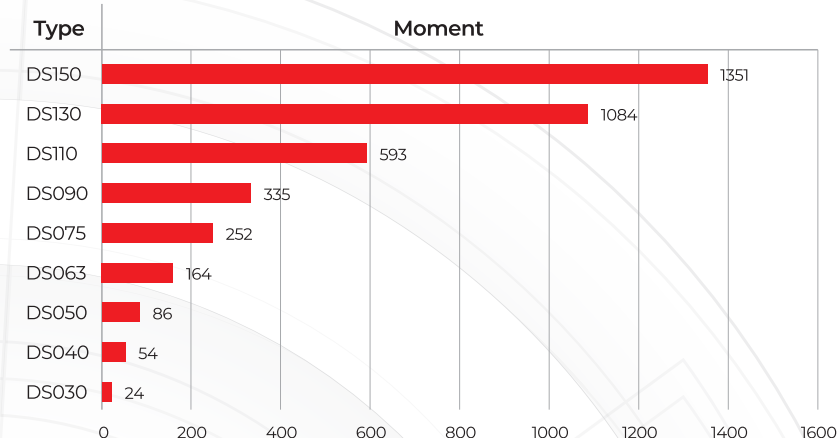

### Features

- 12-2 Bronze level
- Higher worm efficiency
- New IE3/IE4 normal and compact type electric motors
- High quality sealing solutions
- Smooth aluminium and cast iron housing
- Synthetic oil
- B14 and B5 input flange options

### Benefits

- Longer life and lower power consumption
- High performance
- Functional shaft mounting
- Smooth and precise running, reduced and constant backlash
- Spacial solution for heavy duty applications

# GEARBOX

## DG Series

Type	Moment (Nm)
DG3	1300
DG4	1785
DG5	3170
DG6	4680
DG7	7450



5 size DG 3 - 7  
Nominal Torque (M2) up to 7450 Nm  
Transmission ratio (i) 5 ... 20

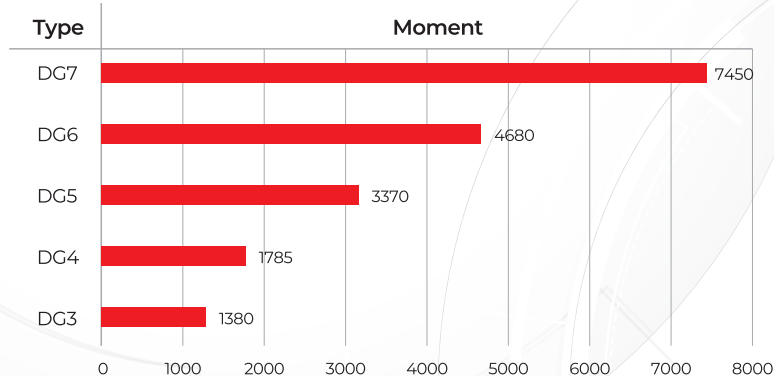

### Features

- Cast iron housing
- Helical toothed gear pairs with ground profile
- Special output shaft options
- Backstop options

### Benefits

- Longer life
- High efficiency design
- Minimum maintenance requirements
- High performance and greater reliability

## DH Series

Type	Moment (Nm)
DH3	4850
DH4	5500
DH5	9000
DH6	11000
DH7	19000
DH8	24000
DH9	29000
DH10	36000
DH11	55000
DH12	70000
DH13	90000
DH14	110000
DH15	150000
DH16	165000
DH17	200000
DH18	240000
DH19	300000
DH20	345000

18 size DH 3 - 20  
Nominal Torque (M2) up to 345000 Nm  
Transmission ratio (i) 1,25 ... 450

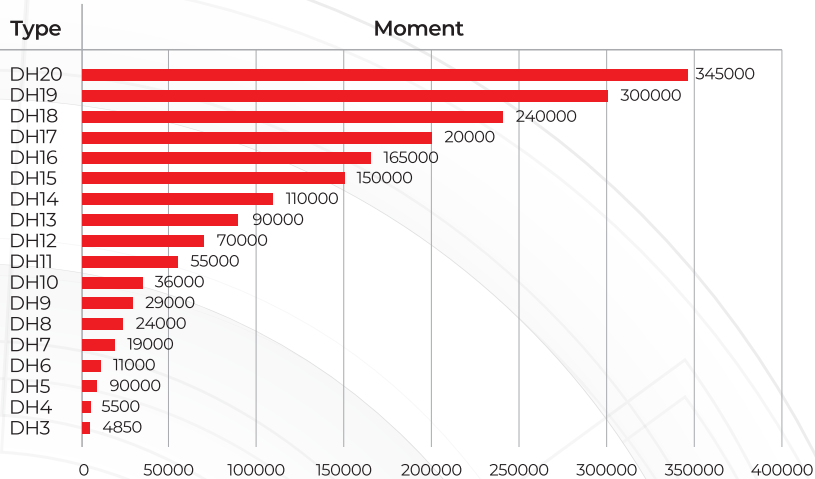

### Features

- Cast iron housing suited for horizontal and vertical mounting
- Helical gear units with 2 and 3 gear stages
- Hardened gear pairs
- Helical gear pairs with ground profile

### Benefits

- Customized solutions on request starting from a standard modular design
- Short delivery times
- Optimized design for heavy industry applications

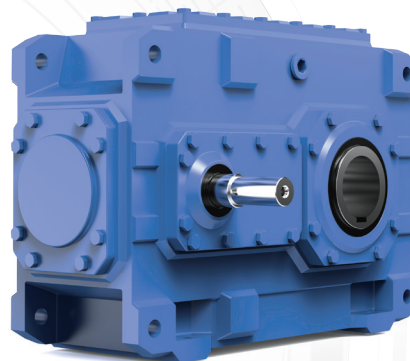

# GEARBOX

## DC Series

Type	Falls	Max. Load [Tones]
DC3	4/1	3
DC4	4/1	5
DC5	4/1	10
DC6	4/1	15-20-25
DC7	4/1	30
DC8	4/1	50

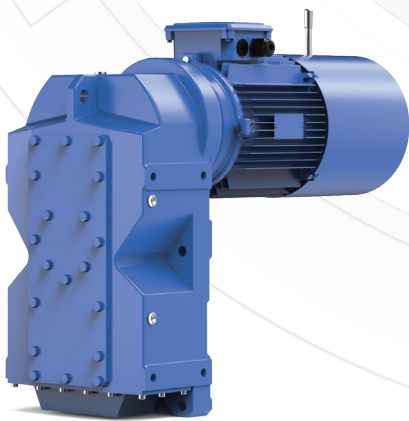
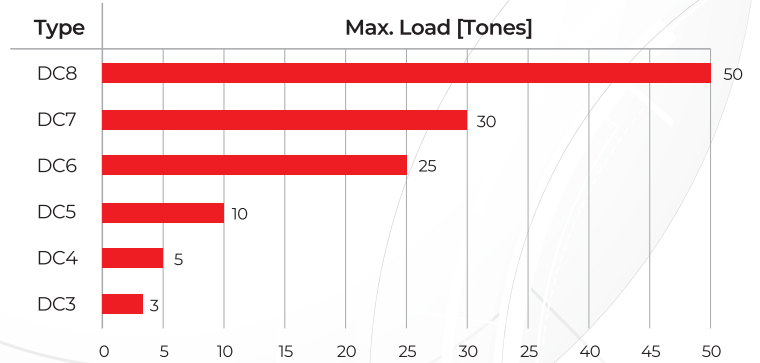

### Features

- New IE3/IE4 normal and compact type electric motors
- Special brake electric motors
- Cast iron housing
- Special connection kit for Crane Drum

### Benefits

- Compact design for Crane Hoist systems
- High efficiency design
- Lower power consumption
- High performance and greater reliability

## PU Series

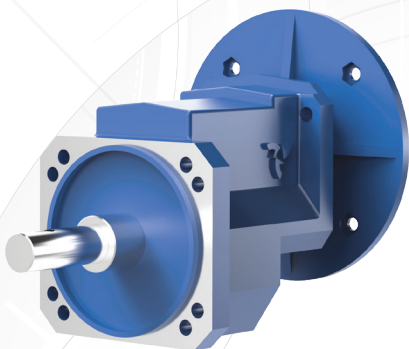

### Features

- Suitable for 80 frame electric motors
- B14 and B5 input flange options
- High quality sealing solutions
- Smooth aluminium housing
- Synthetic oil
- Special output flange options

### Benefits

- New design for poultry sector
- High performance
- Customized shaft as request



# ELECTRIC MOTOR

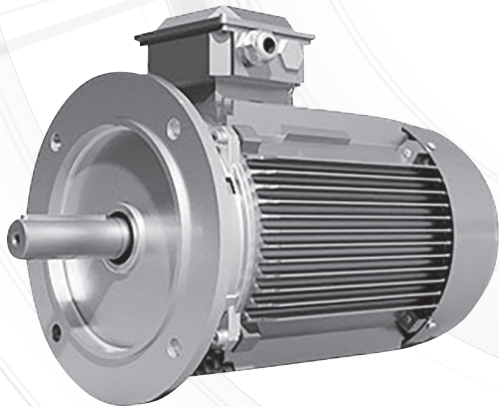

## IEC Electric Motors

- 3 Phase & 1 Phase
- 0,09-400 kW
- Cast Iron & Aluminium housing
- 2,4,6,8,10 and 12 pole
- 56-400L Frame
- IE1-IE2-IE3-IE4

## Flameproof Electric Motors

- 3 Phase
- 0,18-355 kW
- Special Cast Iron housing
- 2,4 and 6 pole
- 63-355L Frame
- IE3 - IE4
- ATEX certified by Italy ECM and Turkey IEP
- II 2G Ex db IIB T4 Gb
- II 2D Ex tb IIIA T125 °C Db

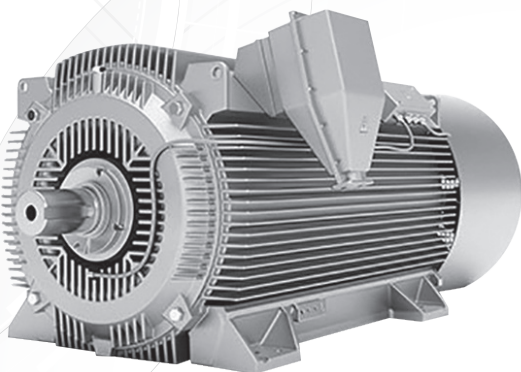
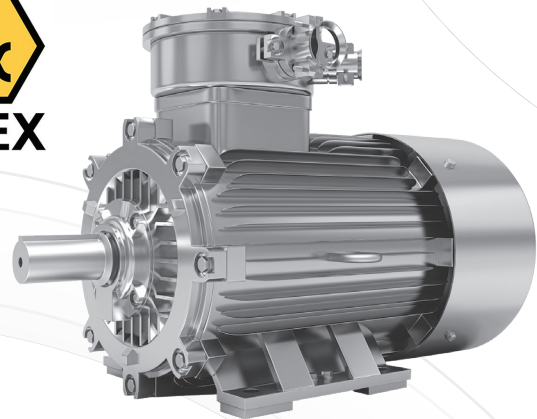

## Middle & High Voltage Electric Motors

- Maximum efficiency, consistent performance and reliability over time.
- High flexibility in use.
- Low noise and low vibrations.
- Compliance with international IEC standards
- IC 01-411-416-511-611-IC 81W Cooling methods

# ELECTROMAGNETIC BRAKE

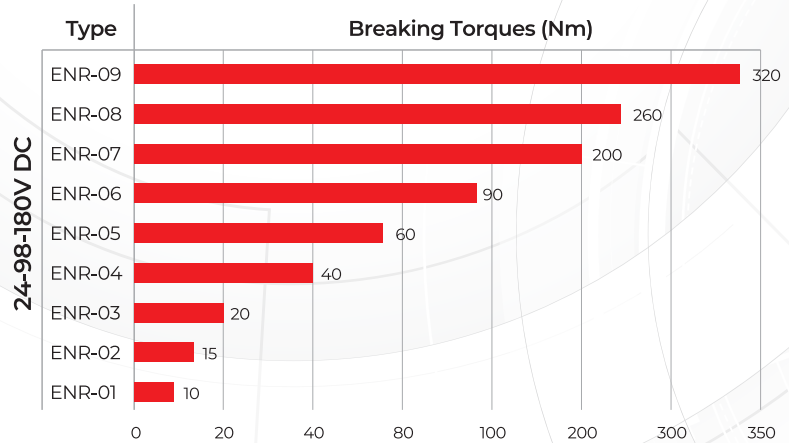

## Features

- Forging, special steel stator frame ensures high efficiency and extra strength
- 24V DC, 98V DC, 180V DC and 380V AC operation voltage
- Quick and easy application with convenient motor endshield
- More efficient by cold braking circuit
- H Class temperature class ( + 180°C)
- IP65 housing for outdoor applications
- By special covering accessories provides to operate very low and very high temperatures
- Easy moment adjust by adjust screw
- Asbestos-Free and tuned shoe
- Assemble encoder by specially design
- By low decibel, according theatre and scene environment application
- Hand release accessory provides to use at doors and load elevators
- Special double Theatre Stage applications

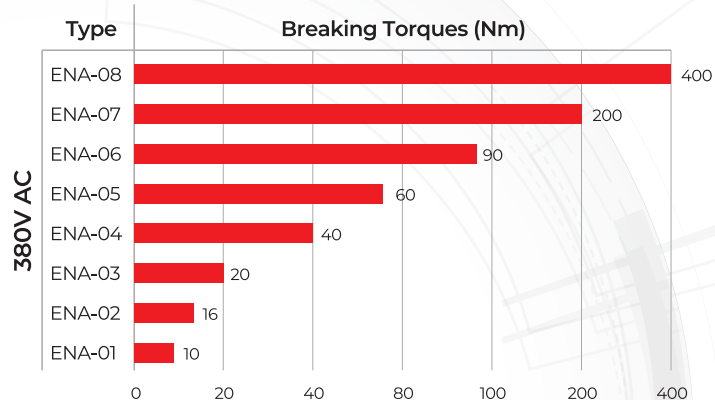

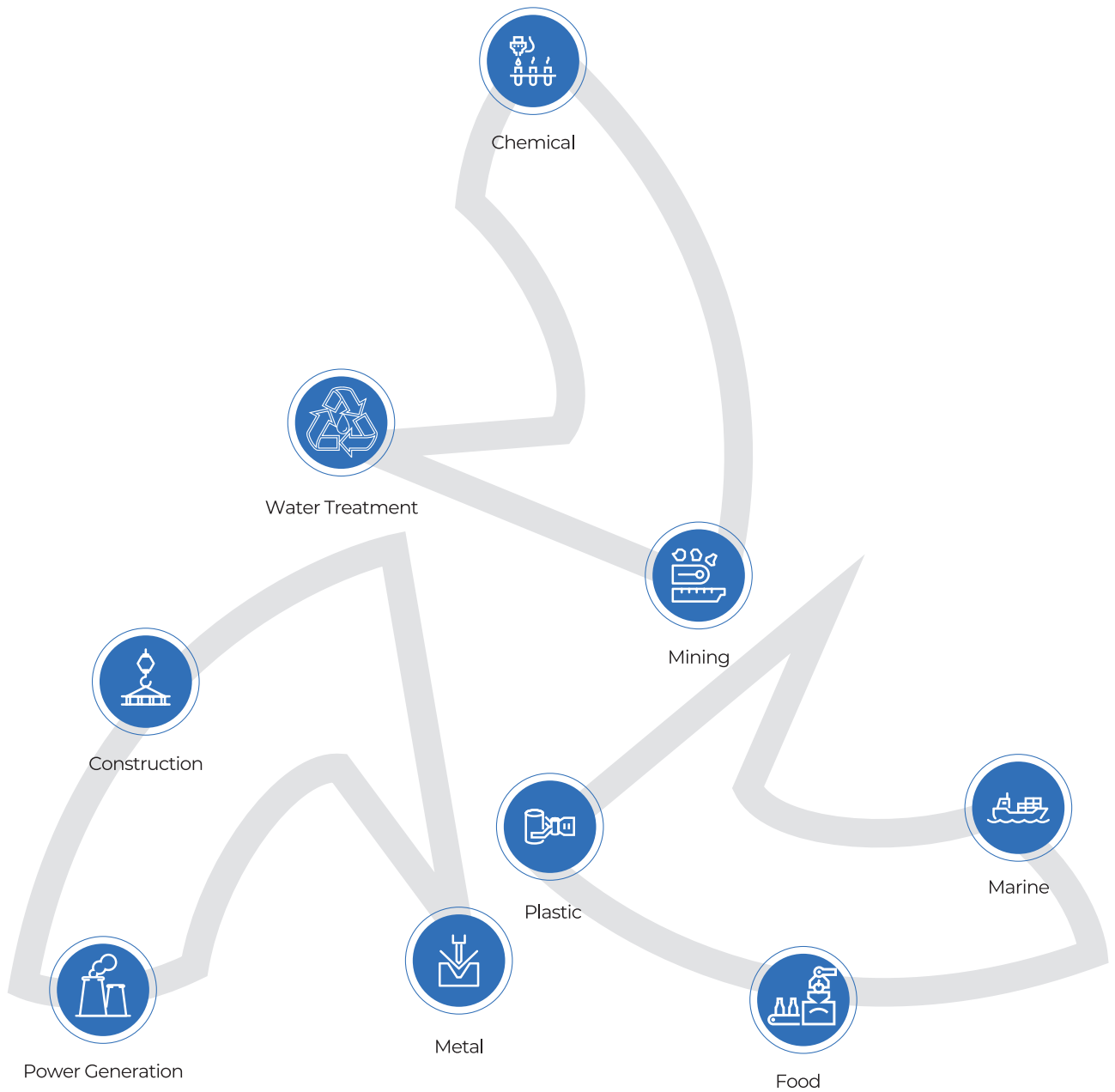



 **dinamik**  
motor redüktör

[www.dgmr.com.tr](http://www.dgmr.com.tr)